

# Fuzzy Logic Based Scheme for Directional Earth Fault Detection and Classification

Radhwan Mohammed Saleem Dawood  
*Electrical Transmission Projects (ETP)*  
*Ministry of Electricity*  
 Iraq  
 radhwansaleem@gmail.com

Gobind Pillai, *IEEE Member*  
*School of Science, Engineering and Design*  
*Teesside University*  
 Middlesbrough, UK  
 g.g.pillai@tees.ac.uk

Maher Al-Greer, *IEEE Member*  
*School of Science, Engineering and Design*  
*Teesside University*  
 Middlesbrough, UK  
 m.al-greer@tees.ac.uk

**Abstract**—This paper presents a fuzzy-logic-based protection scheme for detecting the direction of earth faults in a transmission network using polarized voltage. The IEEE 9-Bus transmission network has been used to test the fuzzy logic scheme in MATLAB/Simulink. The proposed scheme involves the measurement of RMS value of each phase voltage in order to detect occurrence of a fault; the direction of fault is determined by measuring the phase angle between the fault current and the polarized or reference voltage. The proposed scheme has been tested in six earth fault cases, faults in the forward and reverse direction per phase. The simulation results demonstrate that the proposed protection scheme is able to detect earth fault and classify the fault direction accurately within one cycle time.

**Index Terms**— Fuzzy logic, three phase transmission line, fault directional detection

## I. INTRODUCTION

Transmission lines transport electricity from the generating plants to the distribution networks. Often transmissions lines are exposed to environmental conditions that can lead to faults. Weather elements like wind, rain, and light storm are common culprits. Protective relays are used to detect the faults and isolate the faulted area from the rest of the grid as fast as possible in order to minimise the effects of the faults.

The selectivity of the protective devices is crucial; relays have to operate only on faults within their “zone of protection” and do not ordinarily sense faults outside that zone. When a fault happens inside the zone, the protection relay trips the circuit breakers on the zone that is associated with short circuit contributors into the zone. If a fault happens outside the zone, fault current may flow through the zone but the protection relay will not respond for this “through-fault” [1].

By reason of recent technology advances, new and improved relays for protection of power system are being designed and developed. Various modern protection schemes based on artificial neural networks [2-3] and fuzzy logic [4-5] have been developed for protection of three phase transmission lines. The benefit of using fuzzy logic is its simplicity and flexibility over any problem. Fuzzy logic can also be used for problems with absent data or missing information [4].

In the current work, a fuzzy-logic-based protection scheme has been proposed for directional earth fault detection. The

performance of the scheme is tested using the IEEE 9-Bus transmission grid system. The grid has been simulated using Simulink and SimPowerSystems toolbox of MATLAB. The scheme uses the RMS value of the three phase voltages measured at the line, the RMS value of the fault current and polarized (or reference) voltage. The performance of the proposed scheme is tested for faults in the forward and reverse direction alternately.

## II. IEEE 9-BUS GRID FOR TESTING

Fig.1 shows the 9-Bus system used for testing the performance of the proposed protection scheme. The normal voltages of the network are 230 kV. Load A is rated 125 MW, 50 MVAR; load B is rated 90 MW, 30 MVAR, and load C is a 100 MW, 35 MVAR load. Bus BB1 shown in Fig. 1 connected to Generator 1 (16.5 kV/80 MVA) is the swing bus, buses connected to Generator 2 (18kV/80 MVA) and Generator 3 (13.8 kV /110 MVA) are on voltage control mode [6].

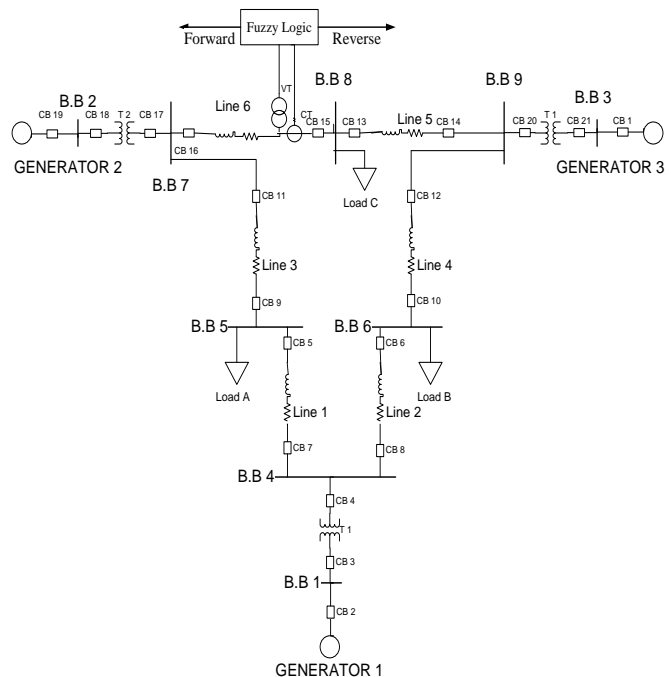

Fig. 1. IEEE 9-Bus Grid

### III. HEALTHY AND FAULTY CONDITION

For proper operation of the detection scheme, fault analysis is required. After the occurrence of the fault in the transmission line, the voltage in the affected phase (the faulted phase) decreases, with there being unnoticeable changes in the other phase voltages. Conversely, the current in the faulted phase increases dramatically while the currents in the healthy phases remain fairly unchanged. The currents and voltages for all three phases therefore have to be taken into consideration in the earth fault direction detection. Fig. 2 shows the voltage waveforms at healthy condition (primary value).

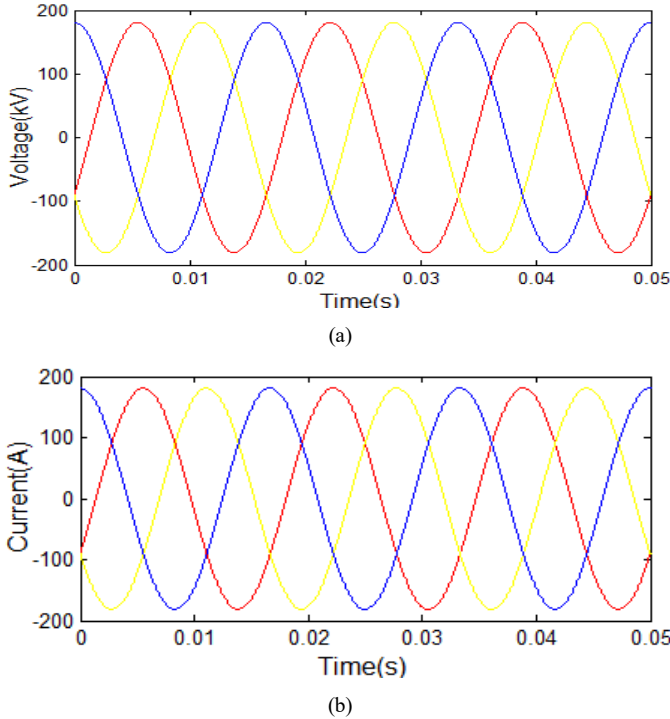

Fig. 2. (a) Three phase voltages waveform at healthy condition, (b) Three phase current at healthy condition

Fig. 3 shows the faulty conditions at bus BB7 during a single line to ground fault (A-G) at 50km after (0.05s) with a fault resistance (0.05  $\Omega$ ).

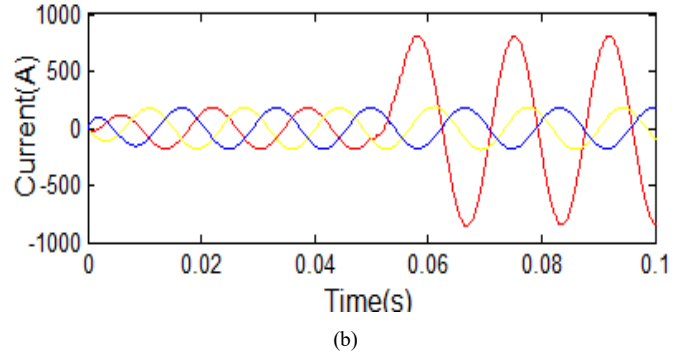
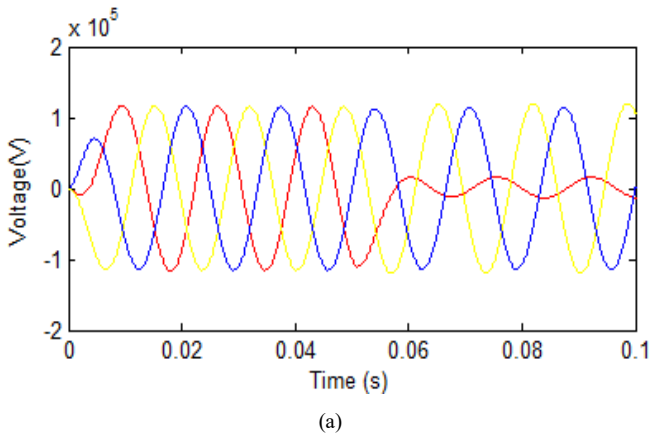

Fig. 3. (a) Three phase voltages waveform in unhealthy condition, (b) Three phase currents in unhealthy condition

### IV. DIRECTIONAL EARTH FAULT DETECTION

The most common methods of directional ground current relay polarization are zero-sequence voltage, zero-sequence current, and negative-sequence polarization [11]. Fig. 4 shows the performance of the reference voltage for the directional ground element based on a single-pole ground fault in phase A. The fault voltage itself is the reference voltage for the directional ground element. Depending on the connection of the voltage transformer, this is the voltage  $3V_0$  as shown in figure 4 or  $V_N$ . The fault current  $-3I_0$  is in phase opposition to the fault current  $I_{scA}$  and is separated from the fault voltage  $3V_0$  by the fault angle  $\phi_{sc}$ ; in this case, a rotation of  $-45^\circ$ . The forward area is also a range of  $\pm 90^\circ$  around the rotated reference voltage  $V_{ref,rot}$ . If the vector of the fault current  $-3I_0$  (or  $I_N$ ) is in this area, the device detects forward direction [7], [9].

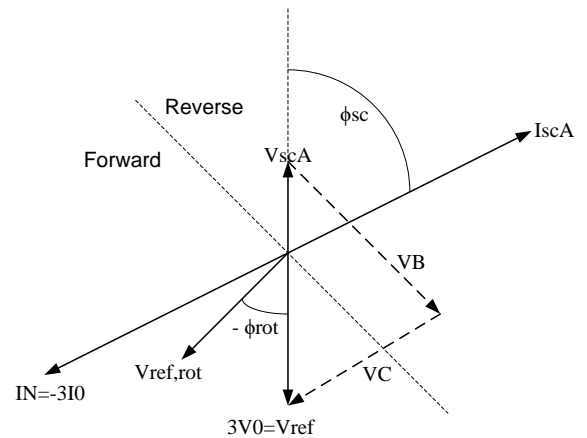

Fig. 4. Rotation of the reference voltage, directional ground element with zero sequence values

### V. FUZZY LOGIC DETECTION AND CLASSIFICATION METHOD

The block diagram of the proposed scheme is illustrated in Fig. 5. The three phase voltages and lines currents are measured by means of a three phase VI measurement tool. The measuring instrument has transformation ratio of 300/5 for line currents and 132.79/63.5 for phase voltages. Discrete Fourier

transform is applied to extract the fundamental components of phase voltages and currents at 60 Hz and associated angles. The measured quantities are then fed as inputs to the proposed fuzzy-logic-based scheme for transmission line fault detection and classification. The output of the fuzzy logic system is an indication of the type and direction of fault present in the line.

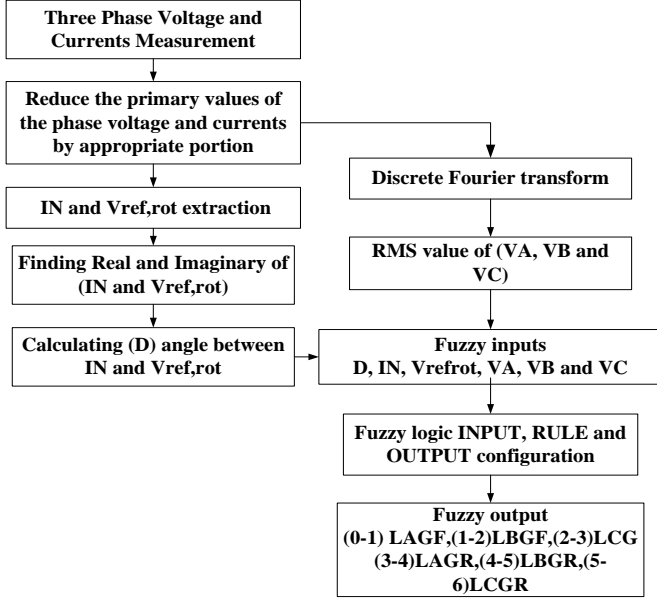

Fig. 5. Block diagrams of the proposed scheme

The block diagram of Fig. 5 illustrates the proposed earth fault direction detection and classification scheme. The scheme utilises five fuzzy inputs: D, IN, VA, VB and VC. The method of preprocessing can be implemented as follows:

1. VA, VB and VC are the (RMS) values of the phase voltages.
2. D is the angular separation between residual current (IN) and residual voltage rotate (Vref rot) which is calculated using dot product [8].

$$a \cdot b = \overline{b \cdot a}$$

Where a and b are two vectors,

Then

$$\cos \varphi = \frac{Re(a \cdot b)}{\|a\| \|b\|}$$

Thus, the angular separation between current vector and residual voltage rotate ( $V_{refrot}$ ) vector is obtained from the following equation:

$$D = \cos^{-1} \frac{Re(V_{refrot} \cdot IN)}{\|V_{refrot}\| \|IN\|}$$

One benefit of using fuzzy logic is its simple and elastic approach to solving any problem; the fuzzy can also be used over problems with partial or lose data [10]. The values of D, IN, VA, VB and VC are used as input to the fuzzy system as shown in Fig. 6. Fuzzy logic toolbox is used for developing the logic for detection and classification of faults.

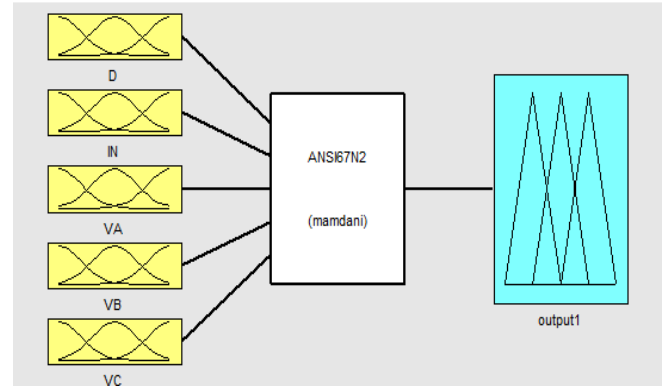

Fig. 6. Three inputs and three outputs for fuzzy logic based fault detector and classifier

The directional earth fault detector algorithm is shown in Fig. 7. In the proposed scheme, the fault detector and classifier observes the fault current IN (or -3I0), angular separation between fault current and residual voltage rotate D, and RMS values of the voltages for the phases A, B and C. If IN is greater than the threshold (which is 20% of the nominal rating of the CTs, 1A in term of secondary CT value [10]), then observe the magnitude of the character D. If D is less than  $\pi/2$  (i.e. FR), the fault is in the forward direction; the fault is in the reverse direction if D is greater than  $\pi/2$  (i.e. R). If the RMS voltage value of phase A is less than the threshold (50 V secondary value) [12], then the fault is phase A to ground fault. A similar approach is used to identify phase B to ground and phase C to ground faults.

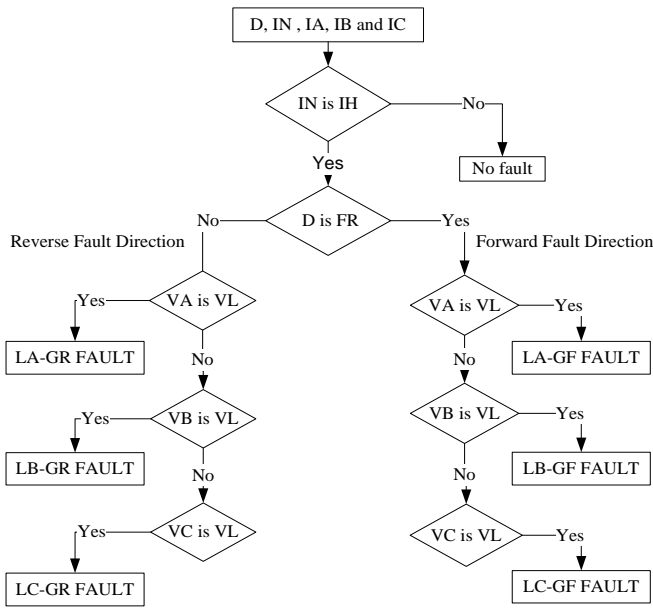

Fig. 7. Flow chart of fuzzy logic functions

The rules of the fuzzy information system are outlined below:

Rule1: If (D is FR) and (**IN** is IH) and (VA is VL) then fault is phase A to ground forward

Rule2: If (D is FR) and (**IN** is IH) and (VB is VL) then fault is phase B to ground forward

Rule3: If (D is FR) and (**IN** is IH) and (VC is VL) then fault is phase C to ground forward

Rule4: If (D is R) and (**IN** is IH) and (VA is VL) then fault is phase A to ground reverse

Rule5: If (D is R) and (**IN** is IH) and (VB is VL) then fault is phase B to ground reverse

Rule6: If (D is R) and (**IN** is IH) and (VC is VL) then fault is phase C to ground reverse

Triangular membership functions have been selected for input as well as output variables. The input and the output membership functions for D, **IN**, VA, VB and VC are shown in table I. Fig. 8 shows the input and output membership fuzzy function editor of Simulink simulation.

	<b>IN</b>	IL	[0 1 2]
		IH	[2 6 10]
	VA	VL	[0 25 50]
		VH	[50 60 70]
	VB	VL	[0 25 50]
		VH	[50 60 70]
VC	VL	[0 25 50]	
	VH	[50 60 70]	
Output		LAGF	[0 0.5 1]
		LBGF	[1 1.5 2]
		LCGF	[2 2.5 3]
		LAGR	[3 3.5 4]
		LBGR	[4 4.5 5]
		LCGR	[5 5.5 6]

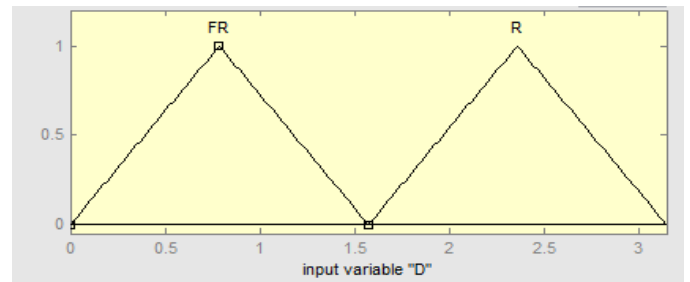

(a)

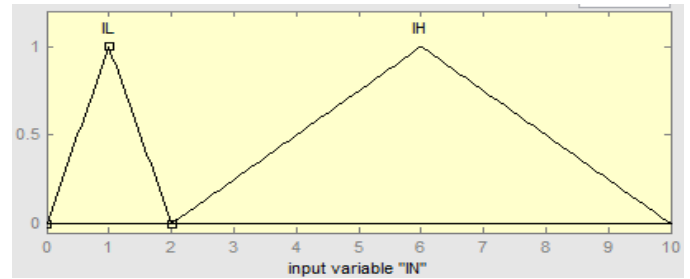

(b)

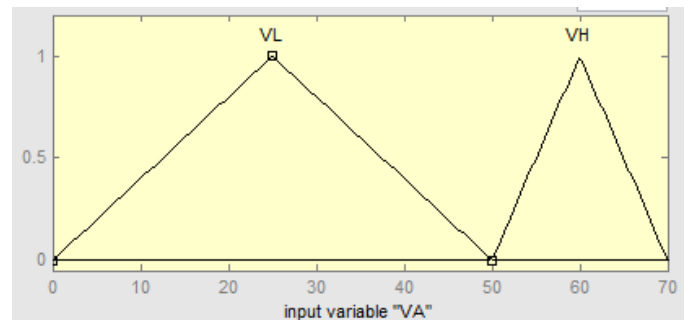

(c)

TABLE I. INPUT AND OUTPUT MEMBERSHIP FUNCTION OF THE FIS

Linguistic term		Fuzzy numbers
INPUT	D	FR
		R

[0 0.7854 1.571]
[1.571 2.356 3.142]

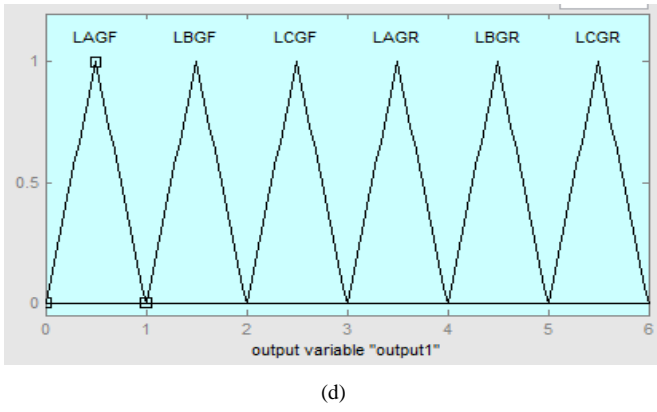

Fig. 8 (a) Fuzzy input membership of D (b) Fuzzy input membership of  $I_{r,ss}$  (c) Fuzzy input membership of IA phase A current Input, (d) Fuzzy output membership function of fuzzy Simulink editor

## VI. RESULTS

To investigate the performance of the proposed fuzzy-logic-based earth fault detector and classifier, 6 fault scenarios are tested. The testing has been accomplished for different bolted fault conditions, by changing the fault location in both forward and reverse condition. The distance of occurrence of fault is 50% in both direction i.e. line 5 and line 6. D,  $I_N$ , VA, VB and VC. The results for all tested cases are given in Table II.

TABLE II. FUZZY INPUTS AND OUTPUTS OF FAULTS FOR FORWARD AND REVERSE DIRECTION

Fault Type	D radian	$I_N$	VA	VB	VC	Fuzzy output	
		RMS (A)	RMS (V)	RMS (V)	RMS (V)		
Fr.	A-G	0.068	9.824	6.104	79.61	79.65	0.5
	B-G	0.068	9.836	77.68	6.109	80	1.5
	C-G	0.068	9.845	80.12	77.77	6.118	2.49
Rev.	A-G	2.556	8.08	11.65	79.32	77.5	3.5
	B-G	2.556	8.08	77.5	11.65	79.32	4.5
	C-G	2.556	8.09	79.48	77.6	11.68	5.5

As an example, the vectors of the fault current  $I_N$  and residual voltage (both are in secondary RMS value) with phase A fault condition in the forward direction are presented in Fig. 9 (a), with the corresponding fuzzy output illustrated in Fig. 9 (b). With "1" output at line A to ground forward condition (LAGF) and "0" output at the rest, fuzzy rule and output membership are exactly matched.

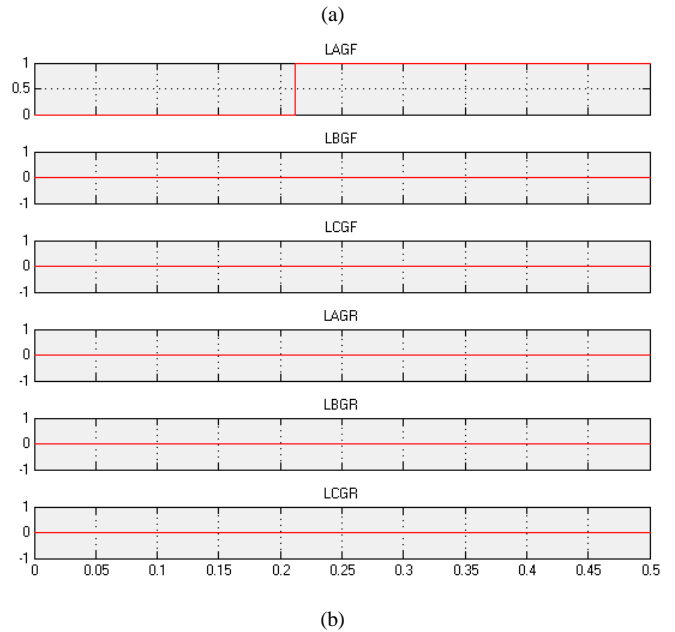
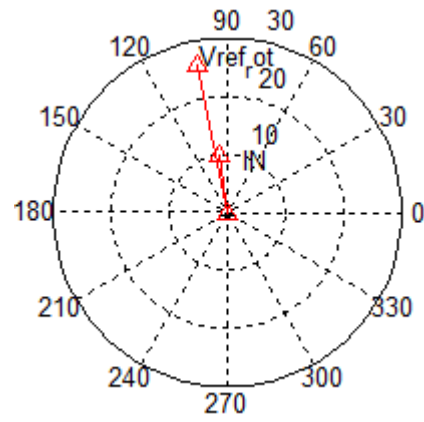
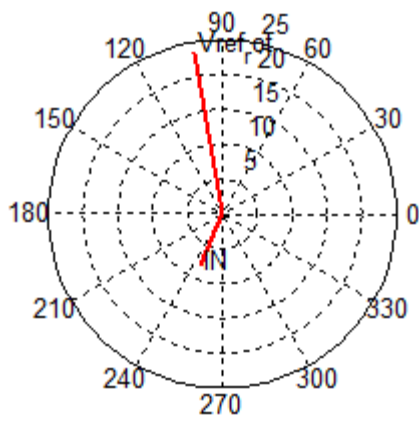
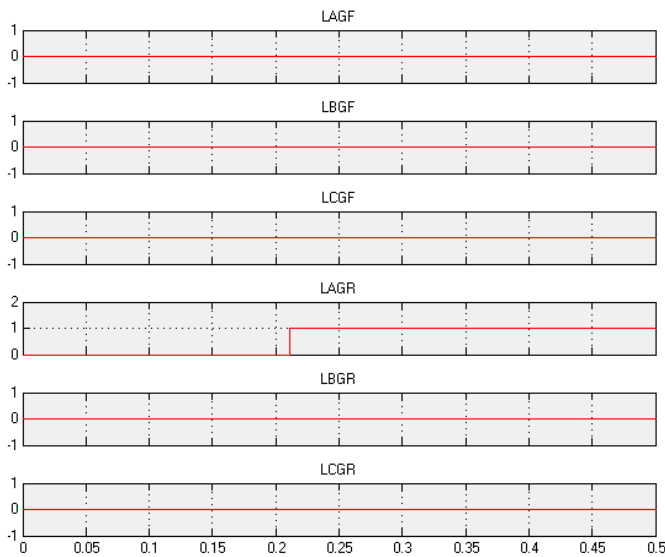

Fig 9. (a) The vectors of the  $I_{r,ss}$  and  $V_{r,ss}$ , rot in forward direction (b) Fuzzy output of phase A to ground in forward direction

The vectors of the fault current and residual voltage (both are in secondary RMS value) of the phase A fault condition in the reverse direction is presented in Fig. 10 (a). The corresponding fuzzy output is illustrated in Fig. 10 (b), with "1" output at line A to ground reverse condition (LAGR) and "0" output at the rest. This exactly matches the fuzzy rule and output membership.



(a)



(b)

Fig. 10. (a) The vectors of the  $I_{r,sd}$  and  $V_{r,sd}$ , rot in reverse fault direction (b) Fuzzy output of phase A to ground in reverse direction

## VII. CONCLUSION

A fuzzy-logic-based protection scheme has been developed for directional earth fault detection and classification in three

phase transmission lines at bus 8 of IEEE 9 bus bar grid. MATLAB/Simulink was used to simulate fault conditions.  $0\Omega$  fault has been simulated in different phases, in both forward and reverse directions. Based on the test results, it can be concluded that the proposed protection scheme is able to detect earth fault and classify the fault direction accurately within one cycle time.

## REFERENCES

- [1] E. Koley, R. Kumar and S. Ghosh, "Low cost microcontroller based fault detector, classifier, zone identifier and locator for transmission lines using wavelet transform and artificial neural network: A hardware co-simulation approach", *International Journal of Electrical Power & Energy Systems*, vol. 81, pp. 346-360, 2016.
- [2] M. Valdes, I. Purkayastha and T. Papallo, "The Single-Processor Concept for Protection and Control of Circuit Breakers in Low-Voltage Switchgear", *IEEE Transactions on Industry Applications*, vol. 40, no. 4, pp. 932-940, 2004.
- [3] E. Koley, A. Yadav and A. Thoke, "A new single-ended artificial neural network-based protection scheme for shunt faults in six-phase transmission line", *International Transactions on Electrical Energy Systems*, vol. 25, no. 7, pp. 1257-1280, 2014.
- [4] B. Das and J. Reddy, "Fuzzy-Logic-Based Fault Classification Scheme for Digital Distance Protection", *IEEE Transactions on Power Delivery*, vol. 20, no. 2, pp. 609-616, 2005.
- [5] S. Samantaray, "A systematic fuzzy rule based approach for fault classification in transmission lines", *Applied Soft Computing*, vol. 13, no. 2, pp. 928-938, 2013.
- [6] P. M. Anderson and A. A. Fouad, *Power System Control and Stability*, 2nd ed. New York: IEEE Press, 2003.
- [7] C. Preve, *Protection of electrical networks*. London: ISTE, 2008.
- [8] S. Lipschutz and M. Lipson, *Linear algebra*. New York, NY [u.a.]: McGraw-Hill, 2009.
- [9] SIEMENS SIPROTEC, "Multi-Functional Protective Relay with Local Control 7SJ62/63/64, Instruction Manual", Siemens AG, 2011.
- [10] T. Ross, *Fuzzy Logic with Engineering Applications*, 3rd Edition. John Wiley & Sons, 2010.
- [11] IEEE, "Std C37.113TM-2015, IEEE Guide for Protective Relay Applications to Transmission Lines", 2015.
- [12] R. Agrawal and E. Koley, "Fuzzy Logic based Protection Scheme for Symmetrical and Unsymmetrical Faults in Three Phase Series Compensated Transmission Line", in *International Conference on Micro-Electronics and Telecommunication Engineering (ICMETE)*, 2016, pp. 471-475.