

Journal of Applied Science (2010), Volume 10 (12): 1134-1139

Removal of CO₂ from Natural Gas using Membrane Separation System:

Modeling and Process Design

¹F. Ahmad, K. K. Lau, A. M. Shariff

Chemical Engineering Department

Universiti Teknologi PETRONAS

Bandar Sri Iskandar, 37150, Perak, Malaysia.

¹E-mail:faizan615@yahoo.com

Key words: Membrane Process, Gas Separation, Natural Gas Processing, CO₂ Removal,
Process Design

Corresponding author: Lau Kok Keong, Chemical Engineering Department, Universiti
Teknologi PETRONAS, Bandar Sri Iskandar, 37150, Perak, Malaysia.

Tel: +605-3687589 Fax: +605-3656176

ACKNOWLEDGMENT

This work was done with the financial support from Universiti Teknologi PETRONAS.

Removal of CO₂ from Natural Gas using Membrane Separation System: Modeling and Process Design

Abstract: Natural Gas (NG) processing is one of the major industrial separation processes. Membrane process, a relatively new technology among other available techniques, can be used for the removal of impurities like carbon dioxide from NG. Membrane performance has been described by different mathematical models over the decades. In this work, a simple mathematical model has been suggested to be incorporated with ASPEN HYSYS in order to design the membrane system for CO₂/CH₄ separation. Parameter sensitivities were analyzed by changing the operating conditions, such as feed composition and pressure and membrane properties (including selectivity of the membrane). Moreover, different configurations have been investigated for the optimized design including single stage (with and without recycle) and double stage membrane systems. It is shown that methane recovery can be improved by recycling permeate stream as well as by using double stage membrane system.

Key words: Membrane Process, Gas Separation, Natural Gas Processing, CO₂ Removal; Process Design

INTRODUCTION

The composition of natural gas varies from source to source. Methane is the major component (75%-90%), but natural gas also contains significant amounts of ethane, propane, butane and 1%-3% of other higher hydrocarbons (Baker and Lokhandwala, 2008). In some deposits, it may contain complex contaminants such as CO₂, H₂S, CO which constitutes environmental hazards and also hindered natural gas processes. The upgrading of low quality crude natural gas is an attracting interest due to the high demand for pipeline-grade gas in recent years. CO₂ needs to be removed in order to; increase the heating value of the gas, prevent corrosion of pipeline and process equipments and crystallization during liquefaction process (Hao *et al.*, 1993; Safari *et al.*, 2008).

CO₂ contents in the NG can vary from 4% to 50% depending upon the gas source. Before the transportation of NG, it must be pre-processed in order to meet the typical pipeline specification of 2%-5% CO (Datta and Sen, 2006). Most of the natural gas, produced in the lower 48 states of USA, contains more than 5% CO₂. Currently, many natural gas wells are shut due to their low production rate and low quality (i.e., high CO₂ and/or H₂S content) (Lee *et al.*, 1994). In Malaysia, NG from Tangga Barat Cluster fields of PETRONAS contains relatively high level of CO₂. Therefore, it has become necessary to develop efficient processes for the removal of CO₂ from NG (PETRONAS media releases, 2008).

CO₂ can be removed by a number of processes considering the factors of; capital and operating costs, gas specifications and environmental concerns. The major processes can be grouped as

- Absorption Processes (Chemical and Physical absorption)
- Adsorption Process (Solid Surface)
- Hybrid Solution (Mixed Physical and Chemical Solvent)
- Physical Separation (Membrane. Cryogenic Separation) (Ebenezer *et al.* 2005; Maddox, 1974; Koros and Chem, 1987)

Membranes processes are commercially proven technology for natural gas processing application. Separation of CO₂ with common polymeric or inorganic (e.g. zeolite, sol—gel silica or carbon molecular sieve) membranes is achieved by differences in terms of diffusion rates and/or adsorption strengths of mixture components in the polymer matrix or the inorganic membrane pores. For a gas to permeate through a membrane surface, the gas must first dissolve in the high-pressure side of the membrane, diffuse across the membrane wall, and evaporate from the low-pressure side. Gas separation therefore works on the principle that some gases are more soluble in, and pass more readily through polymeric membrane than other gases (Ebenezer, 2005; Baker, 2004; Ismail; 2009).

In membrane process, feed gas is pretreated before entering the membrane system to ensure efficient operation. The conditioning of feed stream controls the fouling, plasticization and condensation of hydrocarbons on the membranes (Baker and Lokhandwala, 2008). The pre-treatment equipment depends on the conditions and composition of feed gas. Usually in the case for natural gas, the feed gas is filtered, as a first step, for removal of entrained particulates or aerosols including sand, pipe scale. The feed gas is then cooled in a cooler. Any condensed liquids are removed in the gas/liquid separator. After liquid removal, the feed gas enters the feed preheater. The temperature control system is provided to maintain the gas at the desired operating temperature of the membrane fibers. Finally, the heated gas enters the membrane gas separators where it is separated into two streams; the permeate, a low pressure CO₂ stream and the non-permeate or residue, a high pressure hydrocarbon rich stream (Ebenezer, 2005).

Gas separation by membrane technology has become a major industrial application only during the last few decades but the study of gas separation has a long history (Baker, 2004).

Graham (1866) measured the permeation rates of all the gases then known through different diaphragms (Baker, 2004). Barer (1951), Amerongen (1950) and Stern (1966) played an important role in the development of solution diffusion model for the explanation of gas permeation (Baker, 2004) The first company to establish a Prism membrane was Monsanto for hydrogen separation. The success of Monsanto encouraged other companies like Cynaoi. Separex and Grace Membrane Systems to produce membrane plants to remove CO₂ in natural gas (Baker, 2004; Hennis *et al.*, 1980).

Datta and Sen (2006) optimized the gas processing cost of a membrane unit. It was shown that there was no unique configuration that would always be optimum irrespective of the values of carbon dioxide concentration and cost of natural gas. However, within certain ranges of the carbon dioxide concentration and the cost of natural gas. The optimum

configuration might be unique and the minimum gas processing cost could be achieved by adjusting only the number of modules in each stage and the compressor power.

Wang *et al.* (2004) enhanced operational flexibility and adaptability of membrane process using an optimal method in which auto-controlling of the permeate gas flux was applied for the first time. Moreover, it was shown that the permeate gas flux could be auto-controlled through a control valve installed on the residue gas line.

Qi and Hensen (1998) developed the optimal design strategy for spiral membrane networks for gas separations whereas Lababidi *et al.* (1996) developed the mathematical model to optimize three configurations including single stage, two stages, and the continuous membrane column (CMC). The simple models for the permeability and selectivity variations of the CO₂ /CH₄ system have been derived by Safari *et al.* (2008) that included both temperature and pressure effects simultaneously.

Hao *et al.* (2008) worked on the upgrading of low quality natural gas with CO₂ selective membranes and studied process design, economics, and sensitivity of membrane stage with recycle streams.

Lee *et al.* (1994) made field tests of membrane modules for the separation of carbon dioxide from low-quality natural gas. In their study, they investigated the effects of the operating variables of pressure, feed flow rate, and the carbon dioxide concentration in the feed. In addition, computer models were applied for the separation of gases under perfect mixing and cross flow conditions to the analysis of the field data.

In this paper, membrane processes for gas separation is studied under different configurations using ASPEN HYSYS. Since membrane unit is not a pre-defined unit operation in ASPEN HYSYS, a simple cross flow model is presented for the prediction of membrane performance in the removal of CO₂ from natural gas. The model is then included

as user defined unit operation in the process simulation along with other unit operations in order to design the membrane system configuration.

METHODOLOGY

Governing Equations:

The study is based on the cross flow model as shown in the detailed flow diagram (Fig. 1). The model assumes no mixing in the permeate side as well as on the high pressure side. Thus the composition of permeate can be determined at any point along the membrane by the relative permeation rates of feed component at that point (Weller and Steiner, 1950; Geankoplis, 2003).

The assumptions that follow the suggested model are:

1. It holds for the binary gas mixture
2. Permeability is independent of pressure and temperature of the gas stream.
3. It represents the whole membrane module and will not involve the details inside the module.
4. Pressure drop on both sides of the membrane is negligible.
5. The concentration polarization is assumed to be negligible.

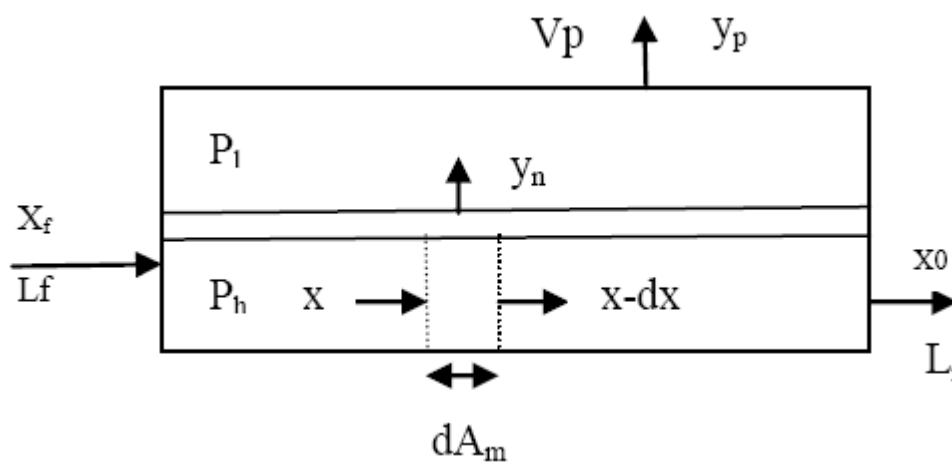

Fig.1. Schematic diagram of cross flow membrane separation

The local permeation rate at any point in the stage over a differential membrane area dA_m is

$$y dV = \frac{P_A}{t} [p_h x - p_l y] \quad (i)$$

$$y dV = \frac{P_B}{t} [p_h (1 - x) - p_l (1 - y)] \quad (ii)$$

Dividing eq (i) by eq (ii), we get

$$\frac{y}{1-y} = \frac{\alpha[x - (p_l - p_h)y]}{(1-x) - \left(\frac{p_l}{p_h}\right)(1-y)} \quad (iii)$$

Using ingenious transformations, an analytical solution to the three equations (eq. (i) - eq. (iii)) have been obtained.

$$\frac{(1-\Theta^*)(1-x)}{(1-x_f)} = \left[\frac{U_f - \frac{E}{D}}{U - \frac{E}{D}}\right]^R \left[\frac{U_f - \alpha + F}{U - \alpha + F}\right]^S \left[\frac{U_f - F}{U - F}\right]^T \quad (iv)$$

where

$$\Theta^* = 1 - L/L_f \quad (L \text{ as flow rate permeated in the differential element})$$

$$i = \frac{x}{(1-x)}$$

$$u = -Di + (D^2 i^2 + 2Ei + F^2)^{0.5}$$

$$D = 0.5 \frac{(1-\alpha)p_l}{p_h} + \alpha$$

$$E = (\alpha/2) - DF$$

$$F = -0.5 \frac{(1-\alpha)}{p_h} p_l - 1, \quad R = 1/(2D - 1)$$

$$S = \frac{\alpha(D - 1) + F}{(2D - 1) - \left(\frac{\alpha}{2} - F\right)}$$

$$T = \frac{1}{1 - D - \left(\frac{E}{F}\right)}$$

The term u_f is the value of u at $i = i_f$. The value of Θ^* is the fraction permeated up to the value of x . At the outlet where $x = x_0$, the value of Θ^* becomes equal to Θ i.e., the total fraction

permeated. The composition of the permeate stream is y_p and thus can be calculated from the overall material balance.

$$y_p = \frac{xf - x_0(i - \theta)}{\theta} \quad (v)$$

Design Configurations:

The design of a membrane separation process involves (i) the configuration of permeators (ii) the operating parameters of the individual permeators (Qi *et al.*, 1998) Different configurations have been proposed for the membrane separation as shown in Fig. 2. For moderate purity and recovery requirement, single stage system (with and without recycle) is appropriate (Schell and Houston, 1982). For more demanding separations, multiple stage system is required (Spillman, 1989; Coady and Davis, 1982). It is a conventional approach to select different configurations and then optimize the operating permeation (Qi *et al.*, 1998).

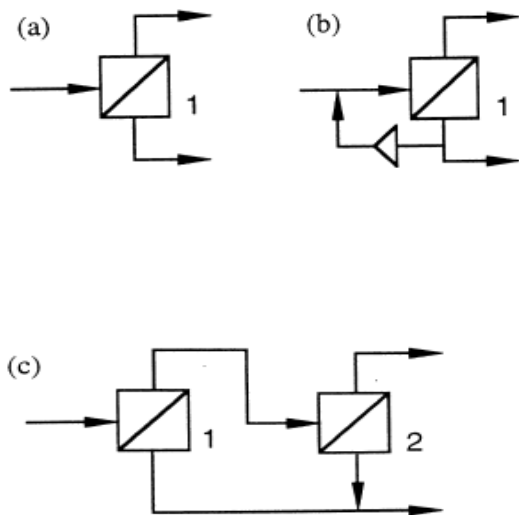
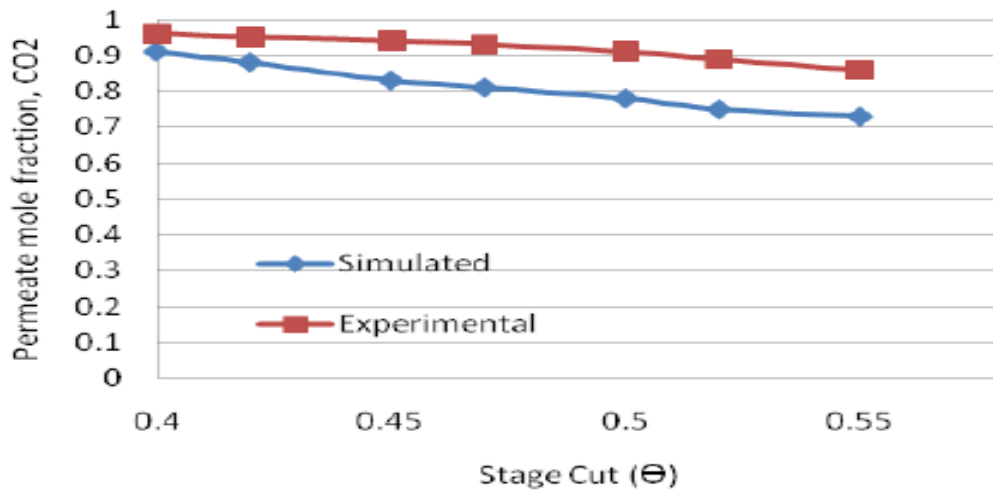

Fig.2. Design configurations for CH₄/CO₂ separations: (a) single stage (b) Single stage with recycle (c) two stage

RESULTS AND DISCUSSIONS

Model Validation:

Mathematical model is validated with the published experimental data for membrane separation process. The data by Pan et al. (1986) is based on the experiments done on sour natural gas. The feed gas contains 48.5 % CO₂ that is removed in the permeate stream, with the purpose to increase the recovery of methane in the retentate stream.



(a)

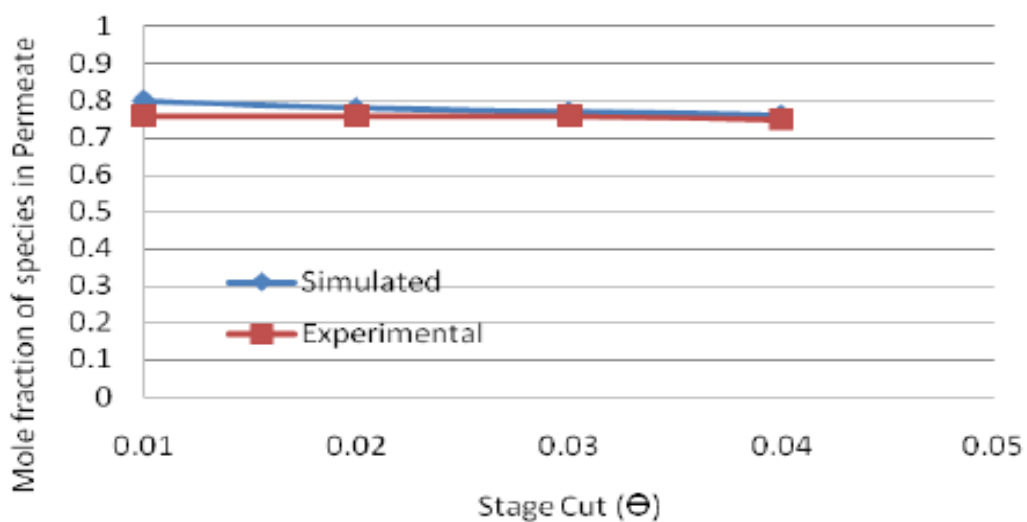

(b)

Fig.3. Validation of mathematical model with experimental data (a) Pan et. al (b) Liu et. al

The temperature and pressure of the gas are 10⁰C and 35.28 bars respectively whereas, on the other hand, the permeate pressure is 9.28 bars. The selectivity is assumed to be 25. Fig. 3(a) shows that the suggested model gives good approximation to the experimental data. The error may be contributed to the sensitivity of methane permeability towards high pressure.

The data from by Liu *et al.* (2006) is based on the study conducted on propylene enrichment using cross flow membrane. Fig. 3(b) shows that the simulated data are in close agreement with the experimental data. It can also be observed that the simulated model gives better approximation with experimental data from Liu *et al.* (2006) as compared to experimental data from Pan *et al.* (1986). It might be due to the fact that the later data takes into account of the effect of pressure drop that has been assumed negligible in the suggested model.

Parametric Analysis:

The methane recovery is considered as the main parameter for membrane system design. The effects of feed composition, feed pressure and the selectivity of the membrane were studied on the methane recovery for different configurations using the suggested cross-flow model.

Effect of feed composition:

Methane recovery decreases with the increase in CO₂ contents of the feed (Qi *et al.*, 1998). At the same time, methane recovery can be improved by recycling the permeate stream as well as using double stage configuration (Schell and Houston, 1982, Spillman, 1989; Coady and Davis, 1982). It is obvious as the portion of first stage permeate that is lost is taken from first membrane module, where CO₂ is highest and hydrocarbon is lowest (Ismail, 2009).

The effect of feed composition on methane recovery for all proposed configurations, for the stage cut of 0.5 and selectivity of 25, is shown in Fig. 4. The feed pressure and permeate

pressure are maintained at 100 and 4 bar respectively. It can be observed that the methane recovery is reducing with the increase of CO₂ in the feed gas. The systems without recycle, as expected, provide the lowest CH₄ recovery. It is obvious as the portion of first stage permeate that is lost is taken from the first membrane module, hence permeate CO₂ is highest and hydrocarbons are lowest. Besides, the simulated results also show that the usage of two stage system could minimize the reduction of CH₄ recovery under high CO₂ feed composition.

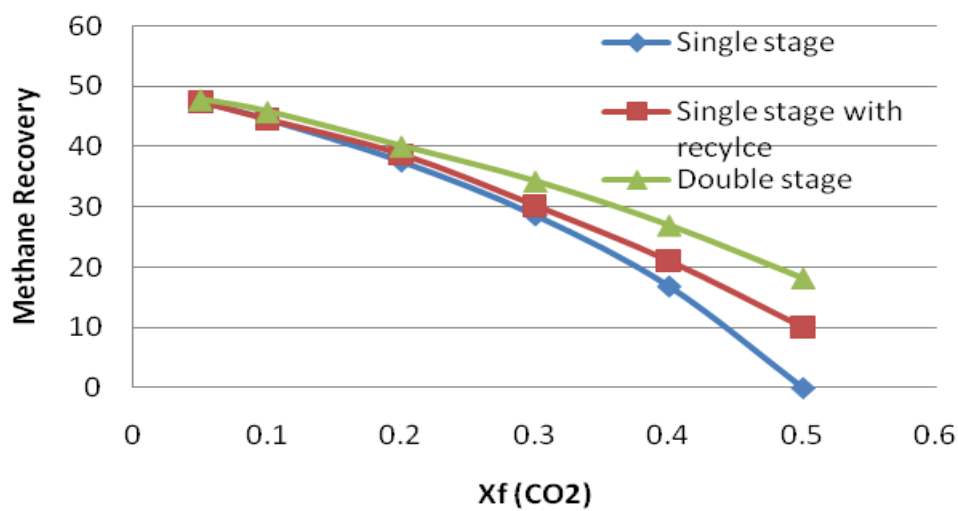

Fig.4. Effect of feed composition on methane recovery

Effect of feed pressure:

The increase in feed pressure improves methane recovery (Ismail, 2009; Qi *et al.*, 1998). It is due to the fact that the increased pressure creates a greater driving force across the membrane. As a result, a net increase in permeation through the membrane increases methane recovery.

Fig. 5 shows the effect of feed pressure on methane recovery for different configurations. The stage cut and selectivity is same as in previous case, whereas the feed gas contains 20% CO₂ and 80% CH₄. The increase in feed pressure increases the methane recovery, especially

when is pressure is less than 70 bar. Based on the figure, the double stage configuration gives the highest recovery followed by single stage with recycle stream and single stage without recycle stream.

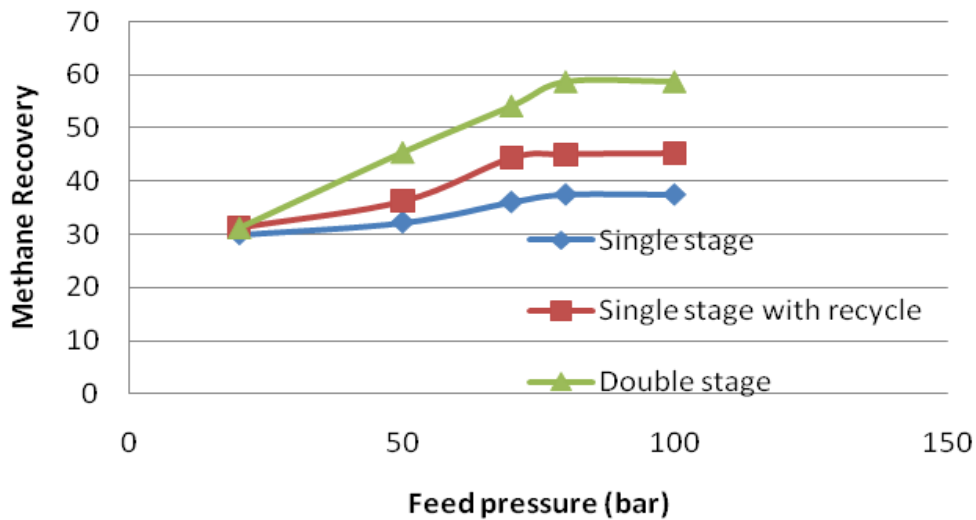

Fig.5. Effect of feed pressure on methane recovery

Effect of membrane selectivity:

Membrane properties have high influence on methane recovery. Methane recovery increases with the increase in selectivity of the membrane (Qi et al., 1998). It is due to the reason that increased selectivity leads to higher permeation and thus improved methane recovery.

Fig. 6 shows the effect of membrane selectivity on the three proposed configurations. As expected, the increase in selectivity increases CH₄ recovery, especially for the configuration with double stage and single stage with recycle stream. It can also be noted that the increment in selectivity for the single stage configuration is less significant on the methane recovery.

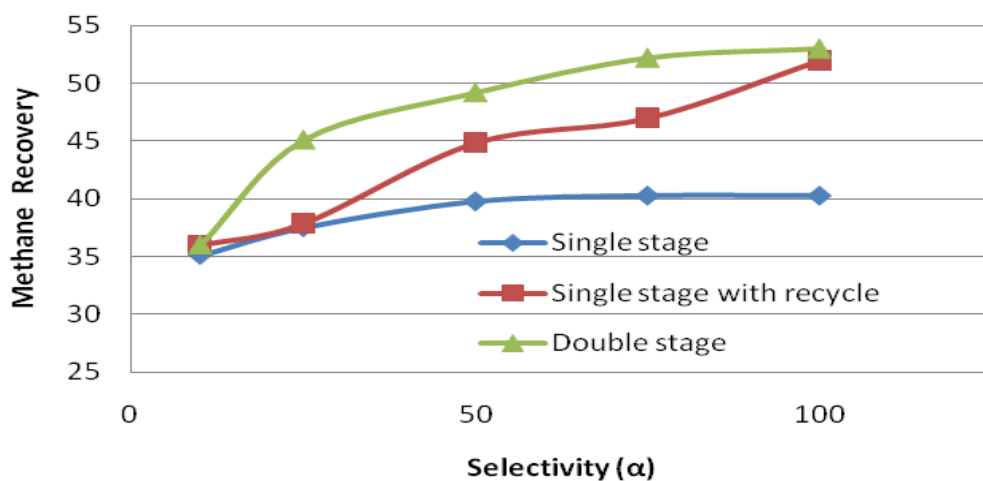

Fig.6. Effect of membrane selectivity on methane recovery

CONCLUSIONS

A systematic design strategy has been proposed for the CH_4/CO_2 separation using membrane process. The proposed cross flow model was validated with experimental data, where the simulated data exhibited good agreement with the experimental results. The design sensitivity has been investigated by changing the operating conditions and membrane properties. Different configurations including single stage (with and without recycle) and double stage membrane systems have been investigated under present study. It is shown that methane recovery can be improved by recycling the permeate stream as well as using double stage configuration. The ASPEN HYSYS user defined unit operation proposed under present study potentially to be applied for complex membrane system design and optimization

REFERENCES

- Baker, R.W. and Lokhandwala K., 2008. Natural gas processing with membranes: an overview. *Industrial Engineering Chemistry Research*, 4: 2109-202.
- Hao, J., Rice, P.A. and Stern S.A., 1993. Membrane processes for the removal of acid gases from natural gas. II. Effects of operating conditions, economic parameters, and membrane properties. *Journal of Membrane Science*, 81: 239-252.
- Safari, M.H., Ghanizadeh, A. and Montazer-Rahmati M.M., 2008. Optimization of membrane-based CO₂-removal from natural gas using simple models considering both pressure and temperature effects. *International Journal of Greenhouse Gas Control*, 3: 3-10.
- Datta A.K. and Sen, P.K., 2006. Optimization of membrane unit for removing carbon dioxide from natural gas, *J. Membr. Sci.* 283: 291–298.
- Lee, A.L., Feldkirchner, H.L., Stern, S.A., Houde, A.Y., Gomez J.P., and H.S. Meyer H.S., 1994. Field tests of membrane modules for the separation of carbon dioxide from low quality natural gas, *Gas sep. Purif.*, 9: 35-43.
- PETRONAS media releases & news, 2008.
- Available:<http://www.petronas.com.my/internet/corp/news.nsf/2b372bb45ff1ab3a48256b42002b19a7/d9473b4fd966e901482574eb002b3fce?OpenDocument> [Accessed 15th March 2010]
- Ebenezer, S.A., 2006. Removal of Carbon dioxide from natural gas for LPG production. Semester project work. Institute of Petroleum Technology, Norwegian University of Science & Technology, Trondheim, Norway.
- Maddox, R.N., 1974. *Gas and Liquid Sweetening*, 2nd ed., Campbell Petroleum series.

- Koros W.J. and R.T. Chern, R.T., 1987. Separation of gaseous mixtures using polymer membranes, Handbook of Separation Process Technology, Wiley, New York, pp: 863–953.
- R.W. Baker, 2004. Membrane Technology and Application, 2nd ed., John Wiley & Sons, Chichester, UK, pp: 287-295.
- Xomeritakis, G., Tsai, C. and Brinker, C.J., 2007. Anodic alumina supported dual-layer microporous silica membranes. Journal of Membrane Science, 287: 157-161.
- Ismail, A.F., 2009. Specialized workshop on membrane gas separation technology. Advanced Membrane Technology Research Centre, Universiti Teknologi Malaysia.
- Graham, T., 1866. On the absorption and dialytic separation of gases by colloid septa”, *Philos*: 401
- Barrer, R.M., 1951. Diffusion in and through solids. Cambridge University Press, London.
- Amerongen G.J., 1950 “Influence of structure of Elastomers on their permeability to gases. J. Appl. Poly. Sci., 5: 307.
- Stern S.A., 1966. Industrial applications of membrane processes: The separation of gas mixtures,” Proceedings of the symposium southern Research Institute, Birmingham.
- Hennis J.M.S. and Tripodi M.K., 1980. A novel approach to gas separations using composite hollow fibre membranes. Sep. Sci. and Tech., 15: 1059.
- Wang, L., Shao, C., Wang, H., 2007. Operation optimization of a membrane separation process through auto-controlling the permeate gas flux. Sep. Purif. Technol. 55: 30, 15.
- Qi, R. and Hensen, M.A., 1998. Optimal design of spiral wound membrane networks for gas separations. Journal of membrane science, 148: 71-89.
- Lababidi, H., Ghazi A., Al-Enezi and Ettoney, H.M., 1996. Optimization of module configuration in membrane gas separation. Journal of membrane Science. 112: 185-197.

- Safari, M.H., Ghanizadeh, A. and Montazer-Rahamti M.M., 2008. Optimization of membrane based CO₂- removal from natural gas using simple models considering both pressure and temperature effects. *International Journal of Green House Control*, 105: 3-10.
- Hao J., Rice P.A. and Stern, S.A., 2008. Upgrading low quality natural gas with H₂S and CO₂ selective polymer membranes Part II. Process design, economics, and sensitive study of membrane stages with recycle streams. *Journal of Membrane Science*, 320: 108-122.
- Geankoplis, C.J., 2003. *Transport processes and separation process principles*” fourth edition, Prentice Hall, New Jersey.
- Weller, S. and Steiner, W.A., 1950. Separation of gases by fractional permeation through membranes. *Journal of Applied Physics*, 21: 180-184.
- Schell, W.J. and Houston, C.D., 1982. Spiral-wound permeators for purification and recovery. *Chem. Eng. Prog.*, 13: 33-37.
- Spillman, R.W., 1989. Economics of gas separation membranes”, *Chem. Eng. Prog.*, 85: 41-62.
- A.B. Coady, J.A. Davis, 1982. CO₂ recovery by gas permeation. *Chem. Eng. Prog.*, 47: 44-49.
- Pan, C.Y., 1986. Gas Separation by high flux, asymmetric hollow fiber membrane. *AIChE Journal*, 32: 2020-2027.
- Liu, L., Chakma, A. and Feng, X., 2006, Propylene separation from nitrogen by poly (ether block amide) composite membranes. *Journal of membrane science*, 279: 645-654.
- Spillman, R.W., Barrett M.G. and Cooley, T.E., 1988. Gas membrane process optimization. In *AIChE National Meeting*, New Orleans, LA
- Babcock, R.E., Spillman, R.W., Goddin, C.S. and Cooley T.E., 1988. Natural gas cleanup: a comparison of membrane and amine treatment processes. *Energy Prog.*, 8: 135–142.